



Dossier

ACRES ENGINEERING



2026

Creative Engineering Solutions

02

Acres Group

05

Services

07

Custom Solutions

13

Recognition & Social Impact

15

Contact

CONTENTS



Engineering for Industrial Environments

ACRES GROUP

Acres develops custom industrial solutions for **handling, logistics, storage, access, assembly and production support**. We help industrial companies optimise shop-floor processes through equipment and systems designed to improve operational efficiency, protect components and provide reliable support for day-to-day operations.

Over 75 years of group experience, the trust of leading companies and recognitions such as *the Manufacturing Impact Award at the Make UK National Awards 2025* support a way of working built around technical expertise, quality, risk reduction and continuous improvement.



75 YEARS OF INDUSTRIAL EXPERIENCE

Acres has supported the evolution of industry by developing technical equipment for **production, maintenance and advanced manufacturing environments**. This track record combines shop-floor experience, engineering knowledge and a way of working focused on solving complex needs with practical, well-executed solutions.

ACRES GROUP



+4000 DESIGNS MANUFACTURED

The wide range of projects delivered allows Acres to apply real experience across sectors such as **automotive, rail, aerospace, defence, energy and advanced manufacturing**. This technical foundation, combined with the trust of leading industrial companies, reinforces a solid response capability for projects with specific requirements, demanding deadlines and a high level of specialisation.





NO. 1 IN INTRALOGISTICS & INDUSTRIAL EQUIPMENT

Acres Engineering develops tailored solutions where standard equipment is not suitable: **trolleys, racks, platforms, workstations, lifting equipment and auxiliary systems** defined around the component, workflow and constraints of each manufacturing environment.

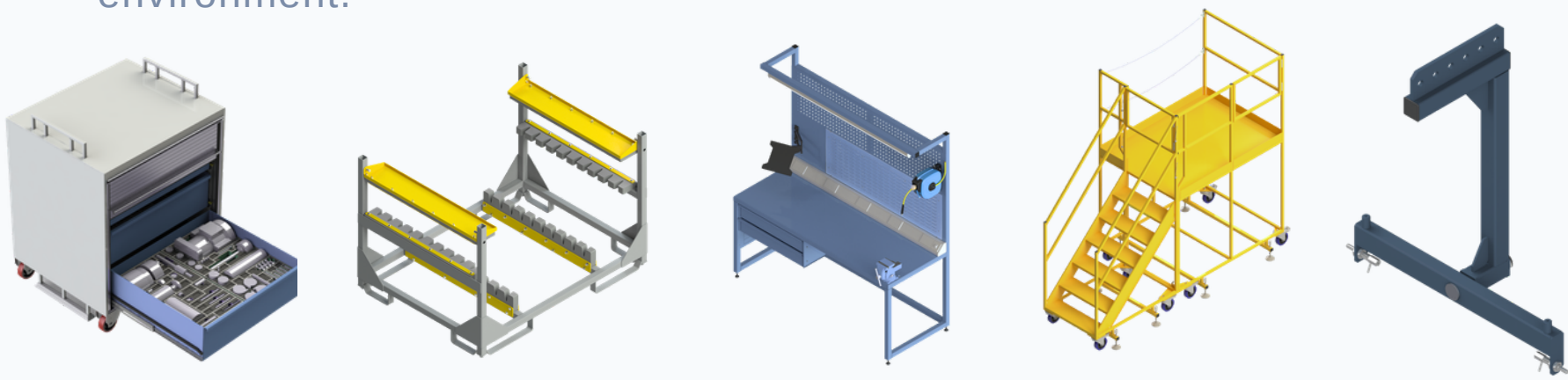



DESIGN, MANUFACTURING & PROJECT DELIVERY

Comprehensive technical support to develop industrial solutions from the initial idea through to final delivery.

SERVICES



INDUSTRIAL DESIGN

Development of custom solutions, functional analysis, modelling, simulations and technical optimisation for manufacturing.



3D DESIGN & PROTOTYPING

3D modelling, visual concepts and prototypes to validate geometry, assembly, accessibility and functionality before manufacturing.



MANUFACTURING & ASSEMBLY

Cutting, machining, welding, finishing, assembly and final equipment verification.



PROJECT MANAGEMENT

Planning, coordination and control to meet deadlines and project objectives.



TECHNICAL DOCUMENTATION & CE MARKING

Drawings, manuals, bills of materials and support for regulatory compliance.

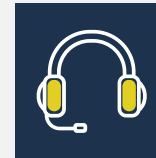

IMPROVEMENT CONSULTANCY

Technical analysis to optimise processes, reduce costs and improve results.

OUR APPROACH



DFMA

Design for efficient manufacturing and assembly.



DTC

Design focused on manufacturing efficiency and total cost reduction.



QUALITY

Technical control and verification at every stage.



FAST RESPONSE

Flexibility to adapt to deadlines and project changes.



END-TO-END SUPPORT

Technical support throughout the entire project.

WORKING PROCESS

01

DEA / REQUIREMENT

Analysis of the technical challenge, customer requirements and working conditions.

02

DESIGN

Analysis of the technical challenge, customer requirements and working conditions.

03

MANUFACTURING

Production through industrial processes, qualified suppliers and technical control.

04

DELIVERY

Final assembly, equipment inspection and preparation for operation.

05

SUPPORT

Follow-up support, adjustment resolution and technical assistance when required.



”

Our methodology combines design, manufacturing and project delivery to provide efficient, reliable and production-ready industrial solutions.



LOGISTICS

CUSTOM SOLUTIONS

Acres Engineering develops solutions to organise the movement of materials, components and tooling within industrial environments. From line-side trolleys and racks to supply systems, each solution is adapted to the workflow, transported component and conditions of the production environment.



MOVE

Efficient transport of materials and components.



SUPPLY

Supporting production and assembly lines.



ORGANISE

Clearer, cleaner and more controlled workflows.

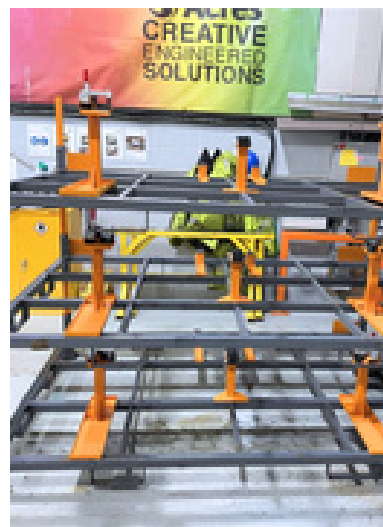
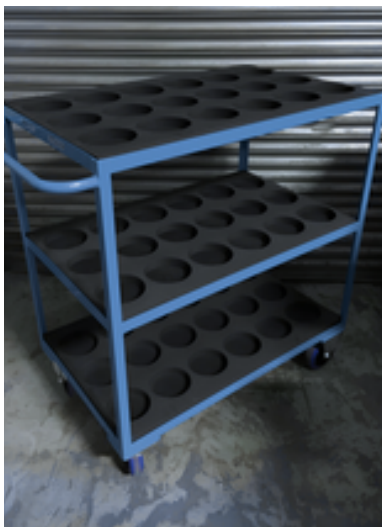

HANDLING

Solutions designed to position, secure and handle components during assembly, maintenance and inspection operations. From rotators and dedicated supports to positioning tools and fixtures, each solution is adapted to the component, operation and working environment.



POSITION

Precise component positioning during assembly and inspection.



SECURE

Stable fixation for improved control during operation.



FACILITATE

Safer, easier and more repeatable access to components.





STORAGE

CUSTOM SOLUTIONS

Solutions designed to store, protect and organise components, tools and equipment within industrial environments. From technical cabinets, storage racks and foam inserts to containers, trays and dedicated supports, each system is adapted to the material, available space and frequency of use.



PROTECT

Safe storage for components, tooling and industrial equipment.



LOCATE

Every item in its place, accessible and controlled.



STANDARDISE

Clear criteria for organising, classifying and protecting materials.



LIFTING EQUIPMENT

Solutions designed to lift, support and move loads safely and in a controlled manner. From lifting beams, support frames and lifting fixtures to crane interfaces and auxiliary equipment, each solution is defined around the component geometry, lifting points and handling conditions.



LIFT

Safe lifting of industrial loads and components.



SUPPORT

Robust structures designed for heavy and specialised loads.



CONTROL

Stable handling during lifting, transport and assembly operations.

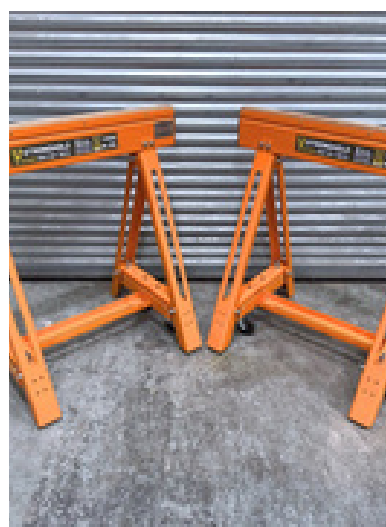



ACCESS & PLATFORMS

Solutions designed to provide safe access to machinery, production lines and elevated working areas. Platforms, stairs, walkways and maintenance structures adapted to the environment, operation and safety requirements.

CUSTOM SOLUTIONS



REACH

Comfortable access to machinery, production lines and equipment.



SECURE

Safety features designed to reduce operational risks.



OPERATE

Stable positioning for inspection and maintenance tasks.

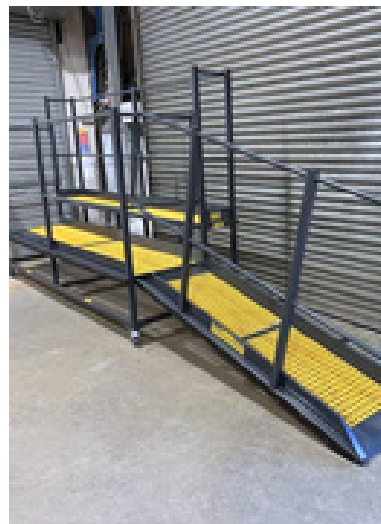

INDUSTRIAL FURNITURE

Solutions designed to equip production, assembly and maintenance work areas. Benches, tables, trolleys, cabinets and auxiliary stations adapted to the process, the operator and the daily organisation of the workspace.



EQUIP

Workstations adapted for production, assembly and quality operations.



ORGANISE

Tools and equipment always accessible and well organised.



OPTIMISE

Improved ergonomics, visual order and day-to-day efficiency.

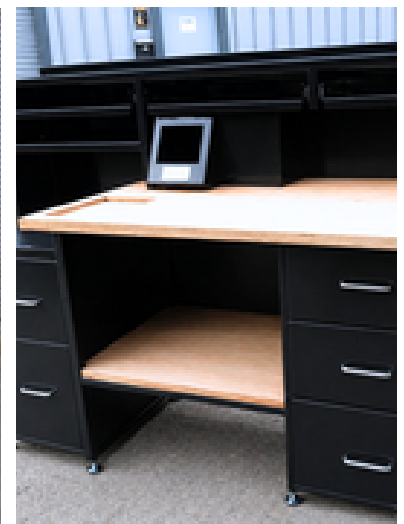



RECOGNISED EXCELLENCE

The recognitions achieved reflect a way of working built around excellence, innovation, people development and commitment to the wider community. Beyond industrial projects, they represent a company culture focused on creating a positive impact both within and beyond industry.



MAKE UK AWARDS WINNER

Recognition for outstanding performance, innovation and contribution to the UK manufacturing sector.



ARMED FORCED COVENANT GOLD AWARD

Recognition for commitment to the Armed Forces community and support for veterans, serving personnel and their families.



THE KING'S AWARD FOR ENTERPRISE PROMOTING OPPORTUNITY

Recognition for promoting opportunity, supporting people development and helping build a more inclusive society.





COMMITMENT TO THE COMMUNITY

Acres maintains a strong commitment to the wider community by supporting initiatives linked to employment, training, inclusion, local communities and opportunity development. This social dimension is part of the company's identity: growing responsibly, contributing to industry and creating a positive impact for the people and communities it works with.



COMMUNITY

Supporting local initiatives and collaborating with the surrounding community.



OPPORTUNITY

Encouraging employment, training and professional development.



INCLUSION

Commitment to more accessible, diverse and inclusive environments.



SUSTAINABILITY

Long-term relationships built on trust, transparency and quality.



TURN YOUR CHALLENGE INTO AN INDUSTRIAL SOLUTION

Acres can transform an industrial requirement into a **practical, manufacturable and production-ready solution**. Each project is reviewed with the customer to define the best technical approach, from real application to manufacturing requirements.

CONTACT



Request a Technical Assessment

Share your project idea or requirement so our technical team can review the application and assess the most suitable solution.



Email

sales@acresengineering.es



Web

acreseurope.com



Teléfono

(+34) 634 11 33 14



Ubicación

Málaga, España



Every complex challenge is an opportunity to engineer something better.

CREATIVE ENGINEERING SOLUTIONS

Design, manufacturing and project management for demanding industrial environments.



**CREATIVE
ENGINEERING**



**CUSTOM
SOLUTIONS**



**QUALITY
MANUFACTURING**



**GLOBAL
PROJECTS**



sales@acresengineering.es



www.acreseurope.com



(+34) 634 11 33 14